



**waldin**<sup>®</sup>  
baby collection

Oval baby bed 7in1

---

Owalne łóżeczko 7w1

---

Ovale Kinderbett 7in1



Znak odpowiedzialnej  
gospodarki leśnej

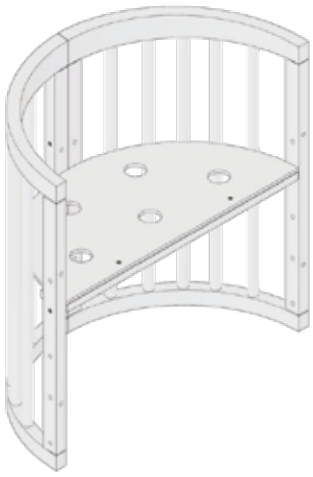



x 4



x 2



x 5



x 1



x 1

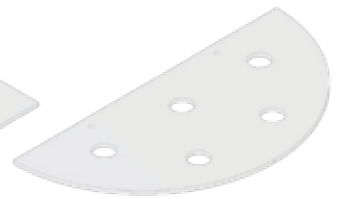

x 2

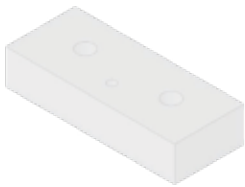

x 2



x 16



M6x60  
x 24



x 12



M6x35  
x 14



x 4



x 1

! Nie dokręcaj  
całkowicie wszystkich  
śrub, dopóki wszystkie  
części nie będą na  
swoim miejscu.

! Do not completely  
tighten all bolts, until  
all parts are in place.

! Nicht vollständig  
anziehen alle Bolzen,  
bis alle Teile sind  
vor handen .

! Ne húzza meg  
az összes csavart  
teljesen csavarokat,  
amíg az összes  
alkatrészek nincsenek  
a helyükön.

! Ne pas serrer  
tous les boulons  
complètement jusqu'à  
ce que toutes les  
pièces ne soient pas en  
en place.

! Nedotahujte  
všetky skrutky úplne  
skrutky, kým všetky  
diely nie sú v  
na svojom mieste.

! Nedotahujte  
všechny šrouby úplně  
šrouby, dokud všechny  
díly nejsou v  
na svém místě.

! No apriete  
todos los tornillos  
completamente  
tornillos hasta que  
todas piezas no  
estén en en su sitio.

! Non serrare tutti  
i bulloni completamente  
viti fino a quando tutte le  
parti non sono in in  
posizione.

! Nu descărcați  
toate șuruburile  
complet șuruburi până  
când toate piesele  
sunt în în poziție.

! Не изтегляйте  
всички винтове  
напълно винтове,  
докато всички части  
са в на място.



x 2

x 1

x 1

x 1

5

6

7

8



x 4

M6x60  
x 6

x 2

M6x35  
x 3

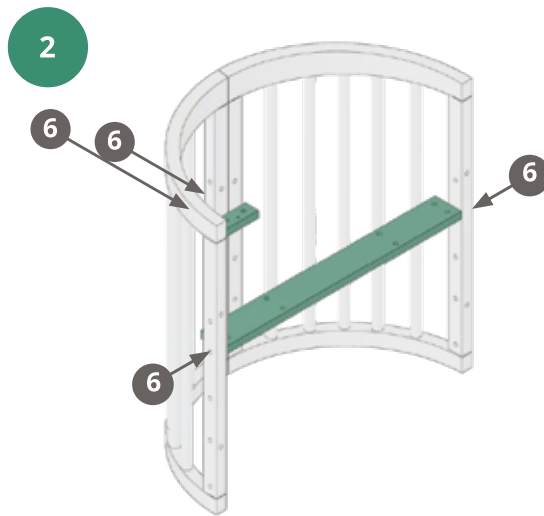
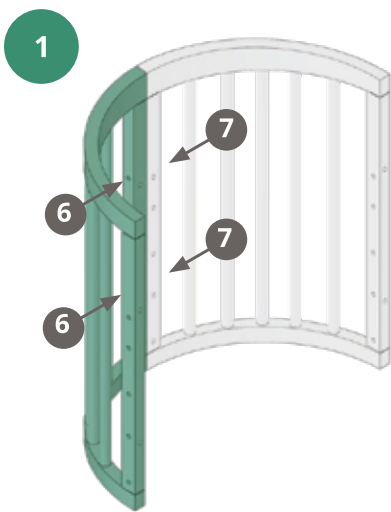
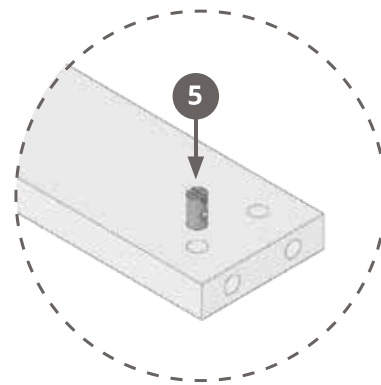
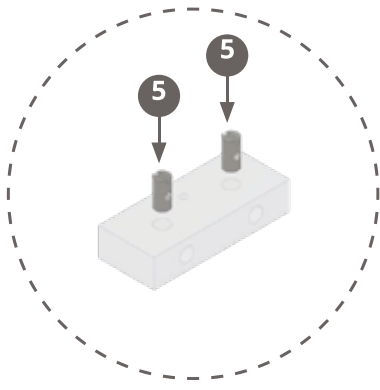



x 2

x 1

x 1

x 4

5

6

8



x 8

M6x60  
x 8

M6x35  
x 8

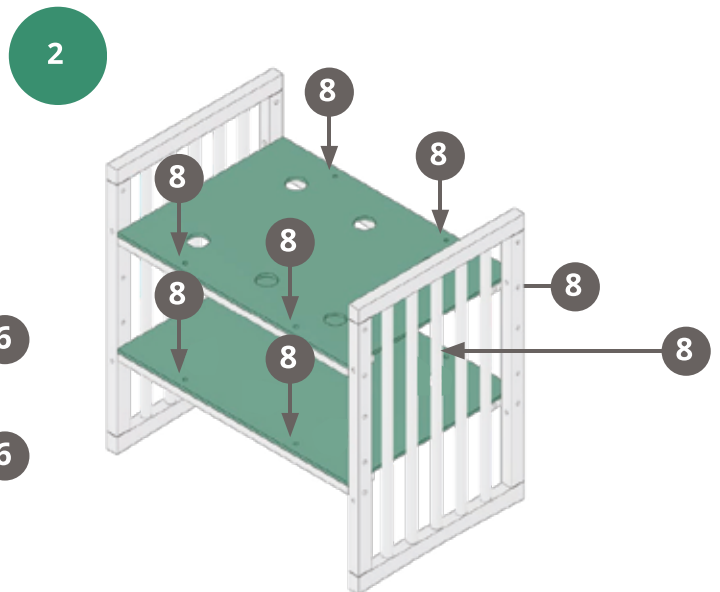
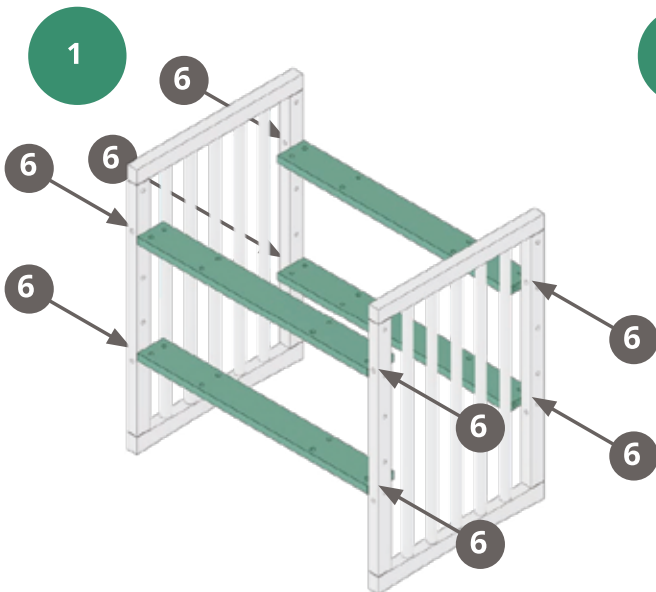
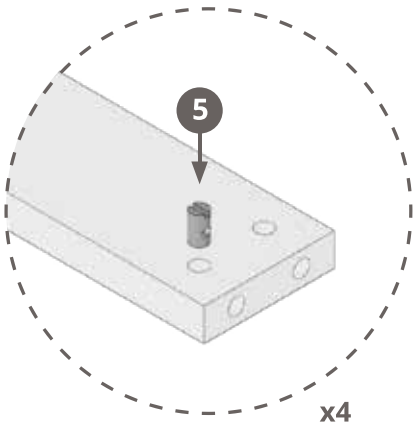

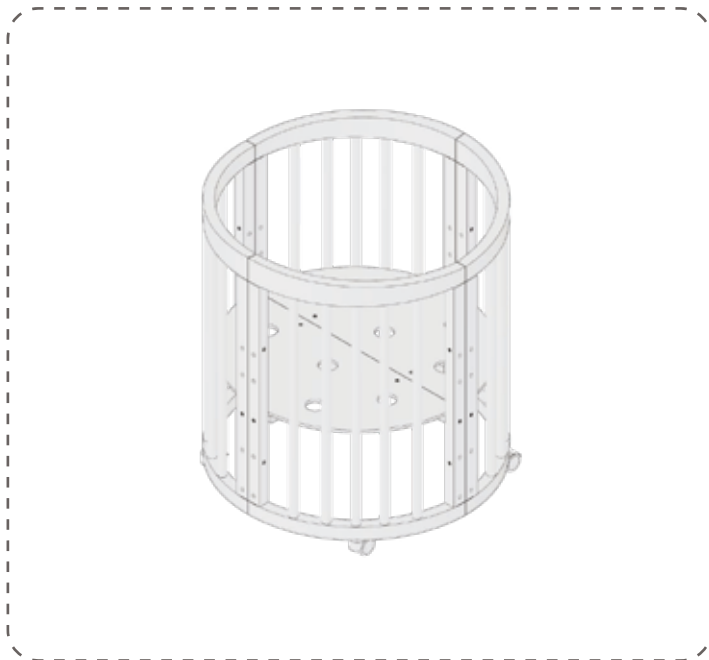

x 4      x 2      x 1      x 2





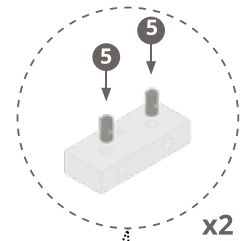



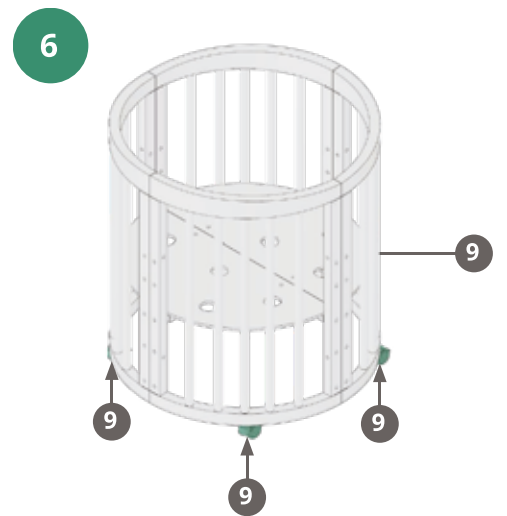
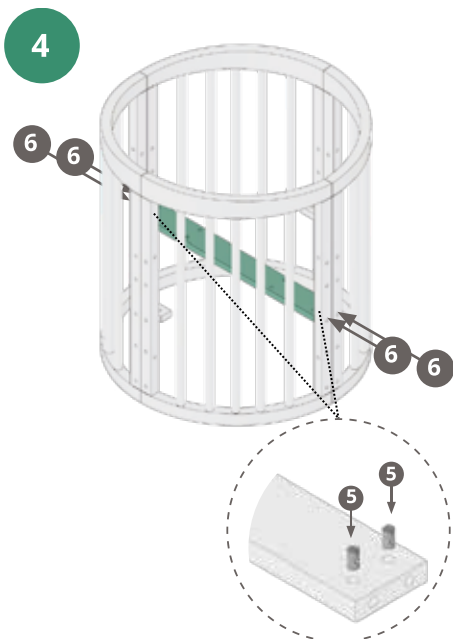
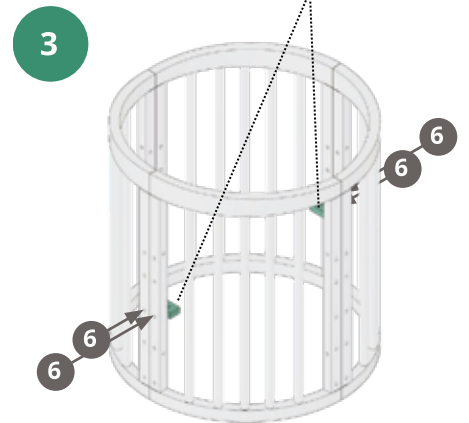
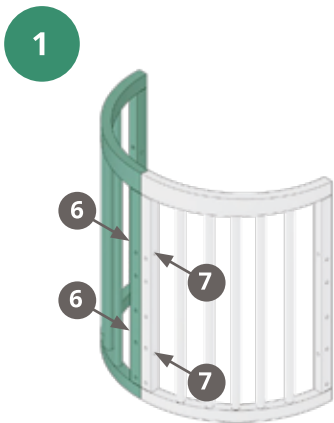



x 8      M6x6  
0 x 16      x 8      M6x35  
x 6      x 4



x2







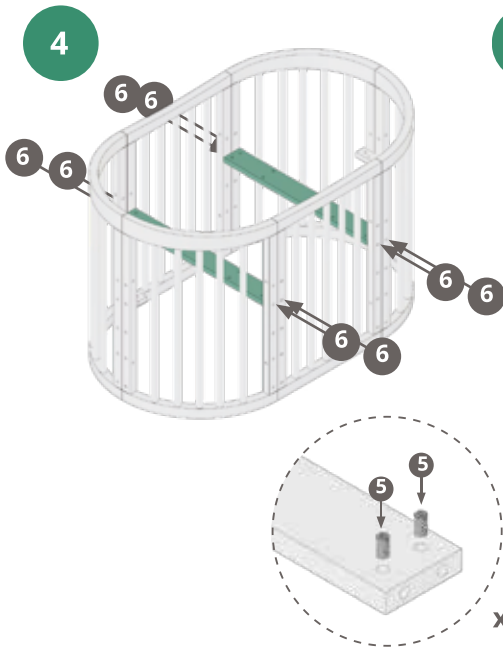
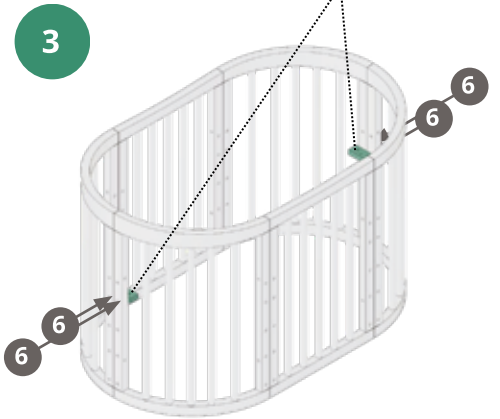
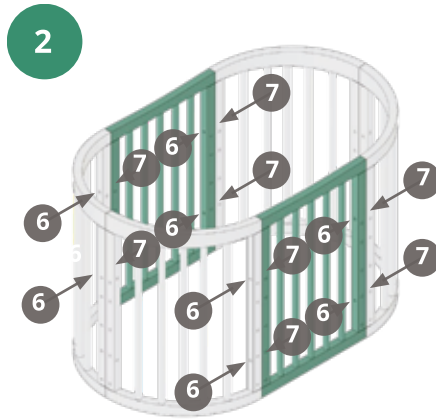
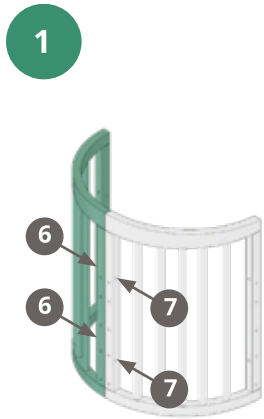











- |   |  |   |   |   |
|---|--|---|---|---|
|  |  |  |  |  |
| x 4   | x 2  | x 2   | x 1   | x 2   |
|  |  |  |  |  |
| x 2   | x 12   | x 24  | x 12  | x 10  |
|  |  |   |   |   |
| x 4   |  |   |   |   |







- |   |   |   |   |   |
|---|---|---|---|---|
|  |   |  |  |  |
| x 4   | x 1   | x 2   | x 1   | x 2   |
|   |   |  |  |  |
|  |  |  |  |  |
| x 2   | x 12  | x 18  | x 8   | x 10  |

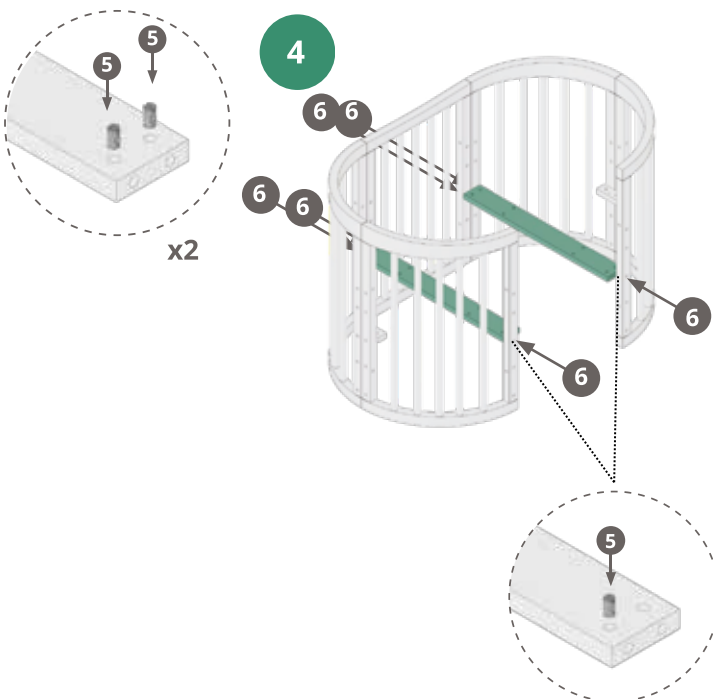
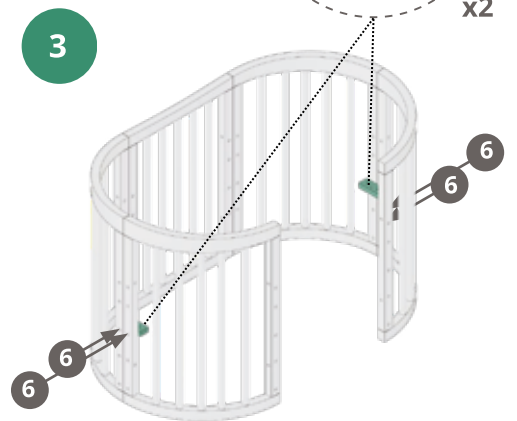
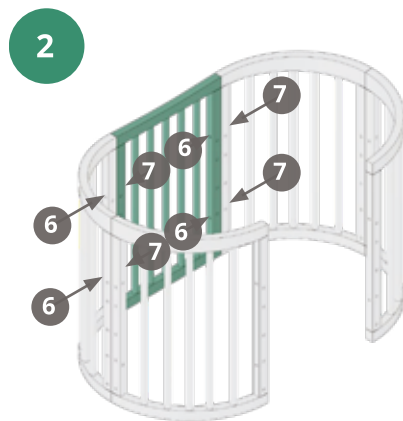



x 4      x 2      x 2      x 1      x 2

5      6      7      8



x 2      x 12      x 24      x 12      x 10

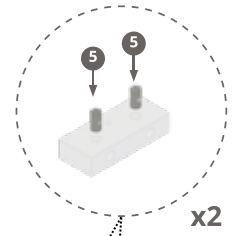

x2

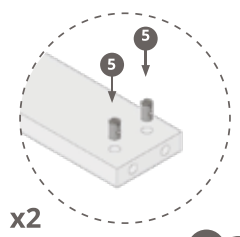
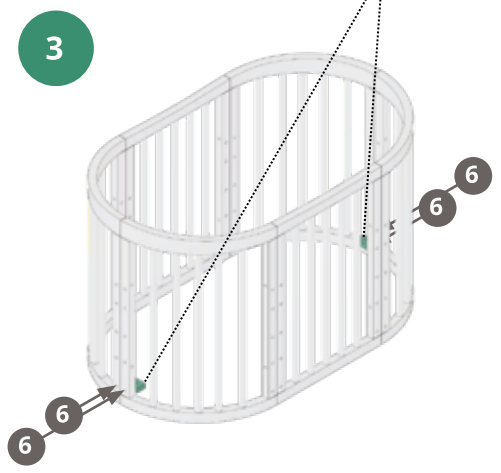
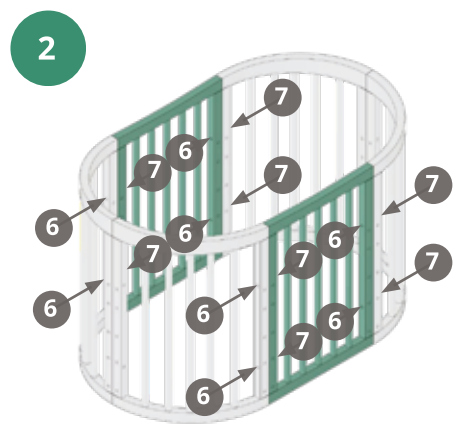

x2

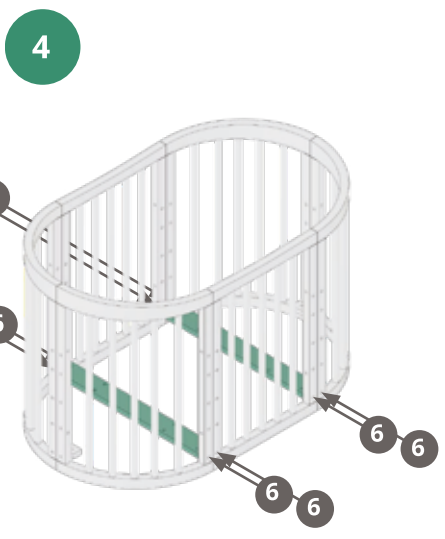



x 2

x 1

x 2

5

6

8



x 4

M6x60  
x 4

M6x35  
x 4

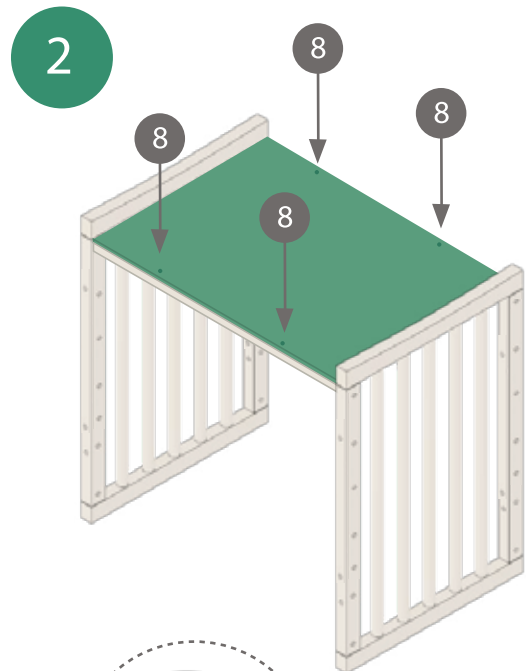
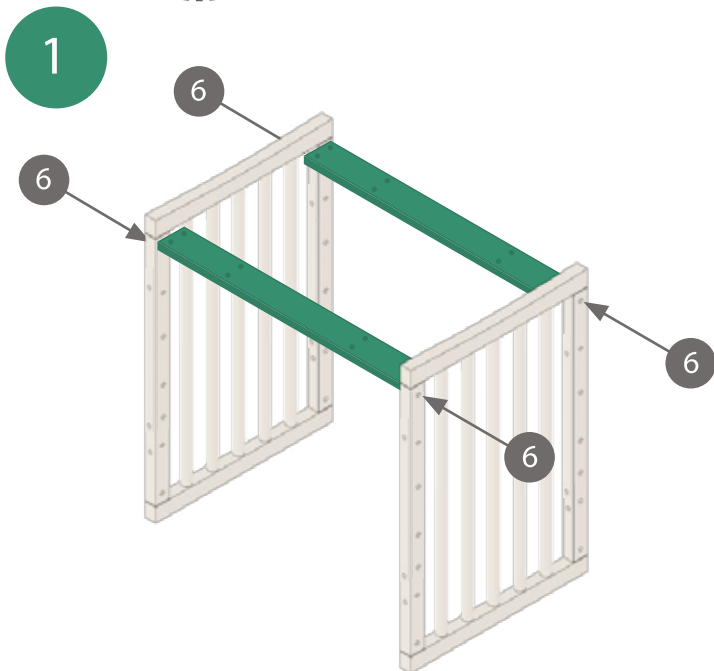
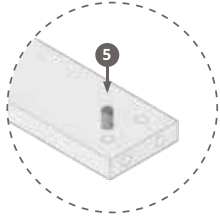
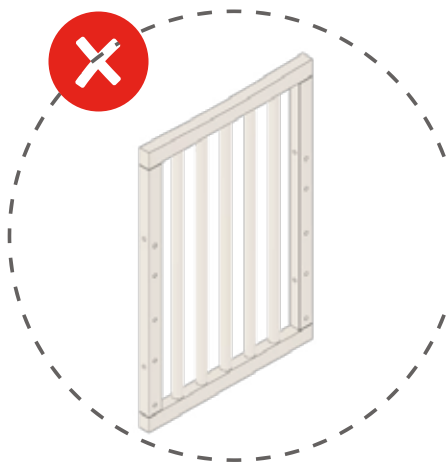

→ str.5 (page 5)

## PL

- Należy pamiętać by w pobliżu łóżeczka nie stosować otwartego ognia i innych źródeł silnego ciepła, takich jak grzejniki elektryczne, kominki gazowe, itp.
- Nie używaj łóżeczka, jeśli jakakolwiek część jest uszkodzona, połamana lub jej brakuje.
- Używaj tylko części rekomendowanych przez producenta.
- Nie pozostawiaj niczego w łóżeczku ani nie umieszczaj łóżeczka w pobliżu innego produktu, który może spowodować złamanie rąk lub nóg, skrępowanie ruchów lub uduszenie, np. : linki, sznurki do rolet, zasłony itp.
- Nie używaj więcej niż jednego materaca w łóżeczku.
- Grubość materaca powinna być taka, aby wysokość wewnętrzna (od powierzchni materaca do górnej krawędzi ramy łóżeczka) wynosiła co najmniej 500 mm w najniższym położeniu podstawy łóżeczka lub co najmniej 200 mm w najwyższym położeniu podstawy łóżeczka.
- Przed użyciem łóżeczka, sprawdź dokładnie, czy wszystkie elementy są dobrze dopasowane i odpowiednio skręcone.
- Nie pozostawiaj dziecka bez opieki w łóżeczku; zawsze upewnij się, że nie będzie w stanie podnieść się przechylić poza barierki łóżeczka.

### Konserwacja

- Zaleca się przechowywanie mebli w stabilnym środowisku o temperaturze nie niższej niż 15 stopni C przy wilgotności względnej w przedziale 50-55%.
- Co 6 miesięcy należy sprawdzić wszystkie mechanizmy blokujące, jeśli to konieczne, dokręcić luźne śruby.
- W przypadku pojawienia się dźwięków przypominających pisk, należy zdemontować łóżeczko i przetrzeć piszczące elementy wilgotną szmatką i pozostawić do wyschnięcia. Następnie należy złożyć łóżeczko zamieniając pozycjami panele boczne.
- Upewnij się, że wszystkie śruby są dokręcone.

## EN

- Do not use open flames or other heat sources such as electric heaters, gas fireplaces, etc. near the crib.
- Do not use the crib if any part is damaged or missing.
- Use only parts recommended by the manufacturer.
- Do not leave any objects in the crib and do not place the crib near other products in which arms or legs can get caught or trapped (e.g. cords for blinds/curtains, etc.)
- Do not use more than one mattress in the crib.
- The thickness of the mattress should be such that the height of the spring core (from the surface of the mattress to the top edge of the slatted frame) is at least 50 cm at the lowest point of the slatted frame or at least 20 cm at the highest point of the slatted frame.
- Before using the crib, carefully check that all parts fit and are properly screwed together.
- Do not leave your baby unattended in the crib – always make sure that he cannot lift himself above the bars.

### Maintenance and care instructions

- It is advisable to store the furniture in a stable environment with a temperature of at least 15°C and relative humidity of 50-55%.
- Check all locking mechanisms every 6 months and retighten loose screws if necessary.
- If squeaking noises occur, disassemble the crib and wipe the squeaking parts with a damp cloth and let them dry. Then swap the positions of the side panels when reassembling the crib.
- Make sure that all screws are tightened firmly.

## DE

- Verwenden Sie keine offenen Flammen oder andere Wärmequellen wie elektrische Heizgeräte, Gaskamine usw. in der Nähe des Kinderbettes.
- Benutzen Sie das Kinderbett nicht, wenn ein Teil beschädigt ist oder fehlt.
- Verwenden Sie nur vom Hersteller empfohlene Teile.
- Lassen Sie keine Gegenstände im Kinderbett liegen und stellen Sie das Kinderbett nicht in der Nähe anderer Produkte auf, in denen sich Arme oder Beine verfangen oder einklemmen können (z.B. Schnüre für Jalousien/Gardinen usw.)
- Verwenden Sie nicht mehr als eine Matratze im Kinderbett.
- Die Dicke der Matratze sollte so bemessen sein, dass die Höhe des Federkerns (von der Oberfläche des der Matratze bis zur Oberkante des Lattenrostes) an der niedrigsten Stelle des Lattenrostes mindestens 50 cm oder an der höchsten Stelle des Lattenrostes mindestens 20 cm beträgt.
- Prüfen Sie vor der Benutzung des Kinderbettes sorgfältig, ob alle Teile passen und richtig zusammengeschraubt sind.
- Lassen Sie Ihr Baby nicht unbeaufsichtigt im Bettchen liegen; achten Sie stets darauf, dass es sich nicht über die Gitterstäbe hinausheben kann.

### Wartung und Pflegehinweise

- Es ist ratsam, die Möbel in einer stabilen Umgebung mit einer Temperatur von mindestens 15°C und einer relativen Luftfeuchtigkeit von 50-55% zu lagern.
- Überprüfen Sie alle Verriegelungsmechanismen alle 6 Monate und ziehen Sie ggf. lose Schrauben nach.
- Wenn quietschende Geräusche auftreten, zerlegen Sie das Kinderbett und wischen Sie die quietschenden Teile mit einem feuchten Tuch ab und lassen Sie sie trocknen. Vertauschen Sie dann die Positionen der Seitenteile beim erneuten Zusammenbau des Kinderbettes.
- Stellen Sie sicher, dass alle Schrauben fest angezogen sind.

## FR

- N'utilisez pas de flammes nues ou d'autres sources de chaleur telles que des chauffages électriques, des feux de gaz, etc. à proximité du lit d'enfant.
- N'utilisez pas le lit d'enfant si l'une de ses parties est endommagée ou manquante.
- N'utilisez que les pièces recommandées par le fabricant.
- Ne laissez pas d'objets dans le lit et ne placez pas le lit à proximité d'autres produits dans lesquels les mains ou les pieds pourraient être happés ou coincés (par exemple, cordons de stores/rideaux, etc.).
- N'utilisez pas plus d'un matelas dans le lit.
- L'épaisseur du matelas doit être telle que la hauteur du noyau du ressort (de la surface du matelas au sommet du sommier) soit d'au moins 50 cm au point le plus bas du sommier ou d'au moins 20 cm au point le plus haut. point le plus bas du sommier à lattes.
- Avant d'utiliser le lit, vérifiez soigneusement que toutes les pièces s'emboîtent et sont correctement vissées.
- Ne laissez pas votre enfant sans surveillance dans le lit - veillez toujours à ce qu'il ne puisse pas dépasser les barreaux.

### Maintenance

- Les meubles doivent être stockés dans un environnement stable, avec une température d'au moins 15 °C et une humidité relative de 55%.
  - Vérifiez tous les mécanismes de verrouillage tous les 6 mois et resserrez les vis desserrées si nécessaire.
  - Si des grincements se produisent, démontez le lit et essuyez les parties grinçantes avec un chiffon humide et laissez-les sécher.
- Ensuite, lors du remontage du lit, intervertissez les positions des côtés.
- Assurez-vous que toutes les vis sont bien serrées.

## ESP

- No utilice llamas desnudas u otras fuentes de calor como calefactores eléctricos, fuegos de gas, etc. cerca de la cuna.
- No utilice la cuna si alguna pieza está dañada o falta.
- Utilice únicamente las piezas recomendadas por el fabricante.
- No deje objetos en la cuna ni coloque la cuna cerca de otros productos en los que puedan quedar atrapados manos o pies (por ejemplo, cordones de persianas/cortinas, etc.).
- No utilice más de un colchón en la cama.
- El grosor del colchón debe ser tal que la altura del núcleo de muelles (desde la superficie del colchón hasta la parte superior del somier) sea de al menos 50 cm en el punto más bajo del somier o de al menos 20 cm en el punto más alto. punto más bajo del somier.
- Antes de utilizar la cama, compruebe cuidadosamente que todas las piezas encajan y están correctamente atornilladas. -No deje a su hijo sin vigilancia en la cama: asegúrese siempre de que no pueda trepar por las lamas.

### Mantenimiento

- Los muebles deben almacenarse en un entorno estable, con una temperatura mínima de 15°C y una humedad relativa del 55%.
- Compruebe todos los mecanismos de cierre cada 6 meses y vuelva a apretar los tornillos sueltos si es necesario.
- Si se producen crujidos, desmonte la cama y limpie las partes que crujen con un paño húmedo y deje secar. A continuación, al volver a montar la cama, invierta las posiciones de los laterales.
- Asegúrese de que todos los tornillos estén bien apretados.

## ITA

- Non utilizzare fiamme libere o altre fonti di calore come stufe elettriche, fuochi a gas, ecc. in prossimità del lettino.
- Non utilizzare il lettino se alcune parti sono danneggiate o mancanti.
- Utilizzare solo le parti raccomandate dal produttore.
- Non lasciare oggetti nel lettino e non posizionarlo vicino ad altri prodotti in cui possano rimanere impigliati mani o piedi (ad es. corde di tende, ecc.).
- Non utilizzare più di un materasso nel letto.
- Lo spessore del materasso deve essere tale che l'altezza del nucleo della molla (dalla superficie del materasso alla parte superiore della rete) sia di almeno 50 cm nel punto più basso della rete o di almeno 20 cm nel punto più alto della rete. -Prima di utilizzare il letto, verificare attentamente che tutte le parti siano montate e avvitate correttamente.
- Non lasciate il bambino incustodito nel letto: assicuratevi sempre che non possa arrampicarsi sulle doghe.

### Manutenzione

- I mobili devono essere conservati in un ambiente stabile con una temperatura minima di 15°C e un'umidità relativa del 55%.
- Controllare ogni 6 mesi tutti i meccanismi di chiusura e, se necessario, serrare le viti allentate.
- In caso di scricchiolii, smontare il letto e pulire le parti scricchiolanti con un panno umido e lasciare asciugare. Quindi, quando si rimonta il letto, invertire le posizioni dei lati.
- Assicurarsi che tutte le viti siano serrate saldamente.

## ROU

- Nu folosiți flăcări deschise sau alte surse de căldură, cum ar fi sobe electrice, focuri de gaz etc. în apropierea pătuțului.
- Nu utilizați pătuțul dacă există piese deteriorate sau lipsă.
- Utilizați numai piesele recomandate de producător.
- Nu lăsați obiecte în pătuț și nu-l așezați în apropierea altor produse în care se pot prinde mâinile sau picioarele (de exemplu, frânghii pentru perdele etc.).
- Nu folosiți mai mult de o saltea în pat.
- Grosimea saltelei trebuie să fie astfel încât înălțimea miezului de resort (de la suprafața saltelei până la partea superioară a somierei) să fie de cel puțin 50 cm în cel mai de jos punct al somierei sau de cel puțin 20 cm în cel mai înalt punct al somierei.
- Înainte de a utiliza patul, verificați cu atenție dacă toate piesele sunt asamblate și înșurubate corect.
- Nu vă lăsați copilul nesupravegheat în pat: asigurați-vă întotdeauna că nu se poate urca pe lamele patului.

## Întreținere

- Mobilierul trebuie depozitat într-un mediu stabil, la o temperatură minimă de 15°C și o umiditate relativă de 55%.
- Verificați toate mecanismele de închidere la fiecare 6 luni și strângeți șuruburile slăbite dacă este necesar.
- I Dacă apar scârțaituri, demontați patul și curățați părțile care scârțâie cu o cârpă umedă și lăsați-le să se usuce. Lăsați să se usuce. Apoi, când remontați patul, inversați pozițiile părților laterale.
- Asigurați-vă că toate șuruburile sunt bine strânse.

## BG

- Не използвайте открит пламък или други източници на топлина, като електрически печки, газови котли и др., в близост до детското креватче.
- Не използвайте детското легло, ако има повредени или липсващи части.
- Използвайте само части, препоръчани от производителя.
- Не оставяйте предмети в детското легло и не го поставяйте в близост до други продукти, в които могат да се хванат ръце или крака (напр. въжета за завеси и др.).
- Не използвайте повече от един матрак в детското легло.
- Дебелината на матрака трябва да е такава, че височината на пружинното ядро (от повърхността на матрака до горната част на основата) да е най-малко 50 cm в най-ниската точка на основата или най-малко 20 cm в най-високата точка на основата.
- Преди да използвате леглото, проверете внимателно дали всички части са сглобени и завинтени правилно.
- Не оставяйте детето си без надзор в леглото: винаги се уверявайте, че то не може да се покатери по ламелите на леглото.

## Поддръжка

- Мебелите трябва да се съхраняват в стабилна среда при минимална температура от 15°C и относителна влажност от 55%.
- Проверявайте всички заключващи механизми на всеки 6 месеца и при необходимост затягайте разхлабените винтове.
- I Ако се появи скърцане, разглобете леглото и почистете скърцащите части с влажна кърпа и ги оставете да изсъхнат. Оставете да изсъхне. След това, при повторното сглобяване на леглото, обърнете позициите на страничните части.
- Уверете се, че всички винтове са затегнати.

## SK

- Upozorňujeme, že v blízkosti detskej postielky sa nesmie používať otvorený oheň ani iné zdroje intenzívneho tepla, ako sú elektrické ohrievače, plynové krbý atď.
- Nepoužívajte detskú postieľku, ak je niektorá jej časť poškodená, zlomená alebo chýba.
- Používajte len diely odporúčané výrobcom.
- Nenechávajte v postielke ani neumiestňujte postieľku v blízkosti iných výrobkov, ktoré by mohli spôsobiť zlomenie rúk alebo nôh, obmedzenie alebo uškrtenie, napr. šnúry, šnúrky, popruhy atď.
- V postielke by sa nemal používať viac ako jeden matrac.
- Hrúbka matraca by mala byť taká, aby vnútorná výška (od povrchu matraca po hornú časť rámu postielky) bola aspoň 5 cm.
- rámu postielky) je v najnižšej polohe základne postielky aspoň 500 mm alebo aspoň 200 mm.
- Pred použitím postielky starostlivo skontrolujte, či sú všetky komponenty správne pripevnené a priskrutkované
- nenechávajte dieťa v postielke bez dozoru; vždy sa uistite, že dieťa nemôže byť zdvihnuté mimo koľajníc postielky.

## údržba

- Nábytok sa odporúča skladovať v stabilnom prostredí s teplotou najmenej 75 °C a relatívnou vlhkosťou medzi 50-55 %.
- Každých 6 mesiacov skontrolujte všetky blokovacie mechanizmy a v prípade potreby dotiahnite uvoľnené skrutky.
- Ak sa vyskytnú výzgové zvuky, rozmontujte postieľku a výzgové časti utrite vlhkou handričkou a nechajte uschnúť. Potom postieľku znovu zostavte výmenou bočných panelov na mieste.
- Uistite sa, že sú všetky skrutky dotiahnuté.

## HUN

- Ne használjon nyílt lángot vagy más hőforrást, például elektromos fűtőtestet, gáztűzhelyet stb. a kiságy közelében.
- Ne használja a kiságyat, ha annak bármely része sérült vagy hiányzik.
- Csak a gyártó által ajánlott alkatrészeket használjon.
- Ne hagyjon tárgyakat a kiságyban, és ne helyezze a kiságyat olyan termékek közelébe, amelyekben a karok vagy lábak beakadhatnak vagy beszorulhatnak (pl. redőnyök/függönyzsinórok stb.).
- Ne használjon egynél több matracot a kiságyban.
- A matrac vastagságának olyannak kell lennie, hogy a rugómag magassága (a matrac tetejétől a kiságykeret tetejéig) legalább 50 cm legyen a kiságykeret legalacsonyabb pontján, és legalább 20 cm a kiságykeret legmagasabb pontján. -A kiságy használata előtt gondosan ellenőrizze, hogy minden alkatrész megfelelően össze van-e illesztve és össze van-e csavarozva.
- Ne hagyja a kisbabát felügyelet nélkül a kiságyban; mindig győződjön meg arról, hogy nem tudja magát átemelni a rácsok felett.

### Karbantartási és ápolási utasítások

- Célszerű a bútorokat stabil környezetben tárolni, ahol a hőmérséklet legalább 15°C és a relatív páratartalom 50-55%.
- Ellenőrizze az összes zárszerkezetet 6 havonta, és szükség esetén húzza meg a meglazult csavarokat.
- Nyikorgó hangok esetén szerelje szét a kiságyat, és a nyikorgó részeket nedves ruhával törölje át, majd hagyja megszáradni. Ezután a kiságy újbóli összeszerelésekor cserélje fel az oldalsó részek helyzetét.
- Győződjön meg arról, hogy minden csavar jól van-e meghúzva.

## CZ

- V blízkosti dětské postýlky nepoužívejte otevřený oheň ani jiné zdroje tepla, jako jsou elektrické ohřívače, plynové krbý apod.
- Nepoužívejte dětskou postýlku, pokud je některá její část poškozená nebo chybí.
- Používejte pouze díly doporučené výrobcem.
- Nenechávejte v postýlce žádné předměty a neumísťujte postýlku do blízkosti jiných výrobků, kde by mohlo dojít k zachycení nebo zachycení rukou nebo nohou (např. šňůry od žaluzií/záclon apod.).
- V postýlce nepoužívejte více než jednu matraci.
- Tloušťka matrace by měla být taková, aby výška pružinového jádra (od povrchu matrace po horní část lamelového rámu) byla alespoň 50 cm v nejnižším bodě lamelového rámu nebo alespoň 20 cm v nejvyšším bodě. bodu lamelového rámu.
- Před použitím postýlky pečlivě zkontrolujte, zda všechny díly do sebe zapadají a jsou správně sešroubovány. - Nenechávejte dítě v postýlce bez dozoru - vždy se ujistěte, že se nemůže zvednout nad příčky.

### Údržba

- Nábytek je vhodné uchovávat ve stabilním prostředí s teplotou nejméně 15 °C a relativní vlhkostí vzduchu o 55%
- Každých 6 měsíců zkontrolujte všechny zajišťovací mechanismy a v případě potřeby dotáhněte uvolněné šrouby.
- I Pokud se objeví vrzavé zvuky, rozeberte postýlku a otřete vrzající části vlhkým hadříkem a nechte je uschnout. Poté při opětovném sestavování postýlky vyměňte polohy bočnic.
- Ujistěte se, že jsou všechny šrouby pevně dotaženy.



**waldin**<sup>®</sup>  
baby collection